

CUBE Spotlight

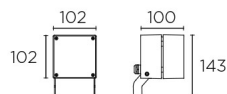

Description

LED Spotlight for outdoor use.

With adjustable lighting positioning. Adjustable light source. Structure material: High purity aluminium. Structure finish: Urban grey. Diffuser material: Polycarbonate. Diffuser finish: Transparent. UV protection. Warranty: 2 Years.11Product net weight (Kg): 0.8851Product length (mm): 1021Product width or diameter (mm): 1021Product height (mm): 14311Class I. IP: IP65. IK: IK10. LED. No. of lampholders or LEDs: 5. LED brand: CREE. Driver brand: EAGLERISE. Maximum power of light source: 15W. Colour temperature: Warm White - 3000K. Colour rendering index: 80. MacAdam Steps: 3 STEPS. Hours of life: 51.000h L90B10. UGR: 14.0. Photobiological risk: RG2. Real flux (lm): 1458. Nominal flux (lm): 1836. Lm/Real W: 78. Voltage and frequency range: 100-240 VAC. Voltage: 3. Intensity: 1000. Gear included: Yes, electronic. Multi-voltage gear included. Total power: 18.6W. Power factor: 0.94.

Finish

Urban grey
Transparent

Material

High purity aluminium
Polycarbonate



TECHNICAL CHARACTERISTICS

Light source

Light source: LED CREE
Output (W): 15W
Total power consumption (W): 18.6W
Color temperature: Warm White - 3000K
CRI: 80
Real Lumen: 1458
Nominal Lumen: 1836
Qty Leds: 5
Lm/Real W: 78
Life Time: 51.000h L90B10
Bin / Grup: 7C1 o 7B4
MacAdam steps: 3 STEPS
UGR: 14.0
Photobiological risk: RG2

GEAR

Brand: EAGLERISE
Gear included: Yes, electronic
Voltage / Frequency:
100-240VAC/50-60Hz
Power Factor: 0.94

Luminaire

Double cable exit: No
Drainage: No
Uv Protection: Yes
Warranty: 2 Years

Logistics

Energy Efficiency: LED A++
EAN Code: 8435381443344
Net Weight (Kg): 0.885
Weight in Kg (packaged): 1.057
Packing: 165 x 110 x 165
Masterbox: 6

The photograph may not match the reference exactly. Please read the product description to identify the finish.

OPTIONAL ACCESSORIES



71-9487-Z5-Z5V1

Structure material: Galvanized steel
Net Weight (Kg): 0.790



71-9941-Z5-Z5

Structure material: Aluminium
Net Weight (Kg): 0.049

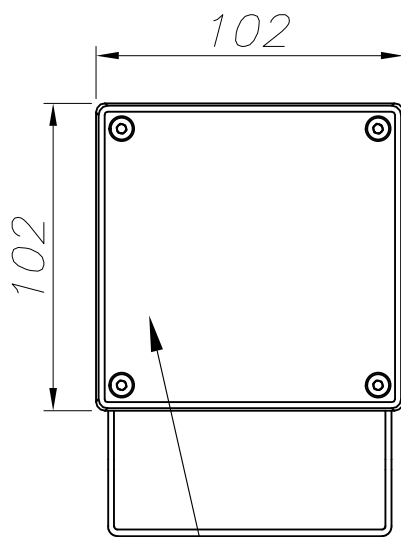

PC TRANSPARENTE
TRANSPARENT PC

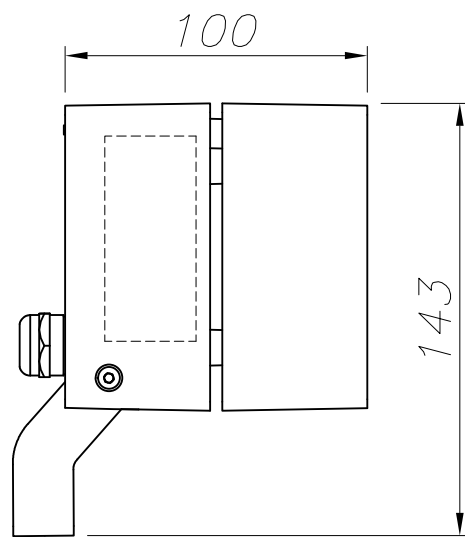

ALUMINIO
ALUMINIUM

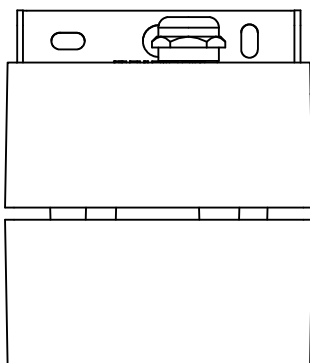

ALUMINIO INYECTADO
INJECTED ALUMINIUM

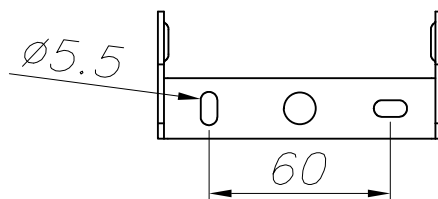

PLANTILLA DE INSTALACIÓN
INSTALLATION TEMPLATE

