

BENTO Downlight recessed

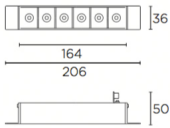

Description
Downlight

For downlighting. UGR <10. Maximum visual comfort with invisible lamp effect. Structure material: Aluminium, Polycarbonate. Structure finish: White, Black. Warranty: 2 Years.11Product net weight (Kg): 0.0001Product length (mm): 2061Product width or diameter (mm): 361Product height (mm): 521Ø of the hole for recessing (mm): 36x1641Permitted ceiling thickness: 0-1811Class III. Luminaire not suitable for coating with insulation materials. LED. No. of lampholders or LEDs: 6. LED brand: CREE. Maximum power of light source: 13.2 W. Colour temperature: Warm White - 3000K. Colour rendering index: 90. MacAdam Steps: 3. Hours of life: 40.000h L80B20. UGR: 7.1. Photobiological risk: RG2. Real flux (lm): 654. Nominal flux (lm): 690. Lm/Real W: 50. Voltage: 3.1 V. Intensity: 700 mA. Gear included: No, but it is needed.



⌀ 36x164

0-18

Finish
White
Black

Material
Aluminium
Polycarbonate



TECHNICAL CHARACTERISTICS

Light source

Light source: LED CREE
Output (W): 13.2 W
Color temperature: Warm White - 3000K
CRI: 90
Real Lumen: 654
Nominal Lumen: 690
Qty Leds: 6
Lm/Real W: 50
Life Time: 40.000h L80B20
Bin / Grup: 7C1 o 7B4
MacAdam steps: 3
UGR: 7.1
Photobiological risk: RG2

GEAR

This item requires gear. It is not included.

Luminaire

Warranty: 2 Years

Logistics

Energy Efficiency: LED A++
EAN Code: 8435526843299
Net Weight (Kg): 0.000
Packing: 100 x 100 x 260
Masterbox: 1

The photograph may not match the reference exactly. Please read the product description to identify the finish.

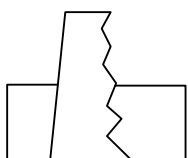
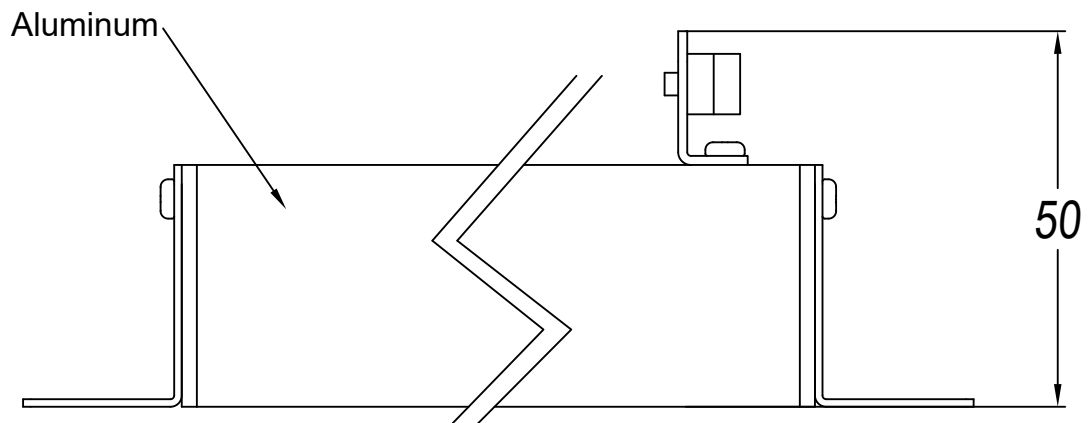
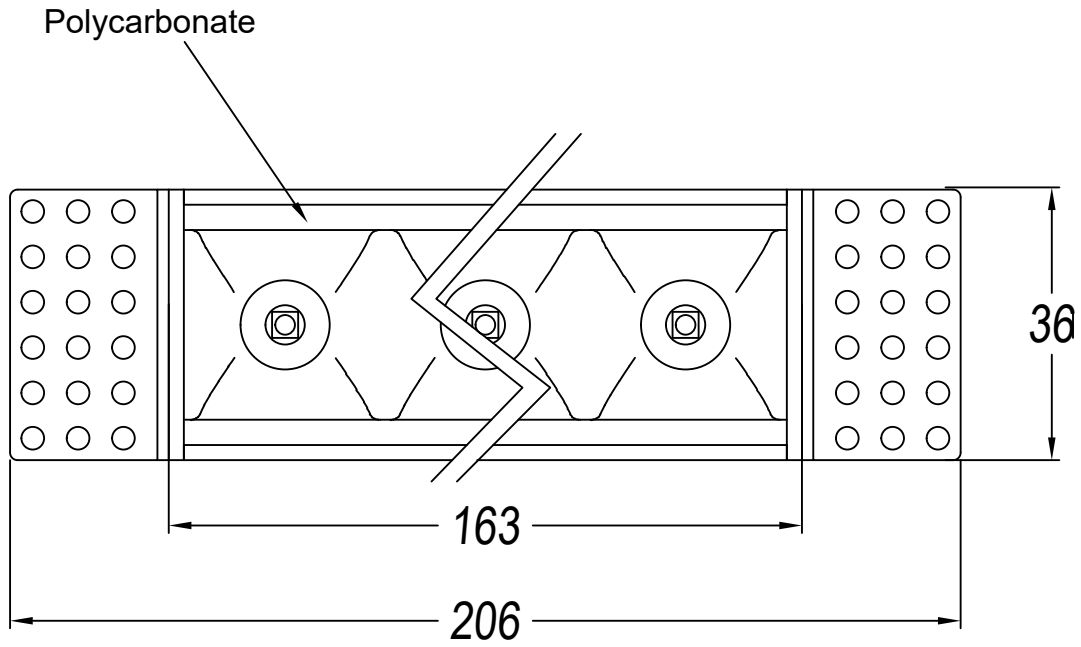

36x164

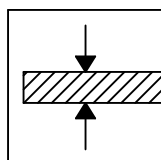

0-18mm

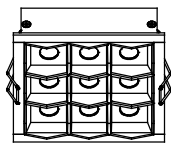
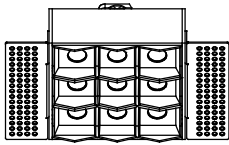
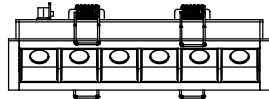
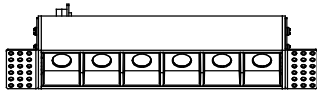

TRIMLESS

- 3LEDS: 36x84mm
- 6LEDS: 36x164mm
- 12LEDS: 36x323mm
- 18LEDS: 36x482mm
- 3X3LEDS: 90x90mm

TRIM

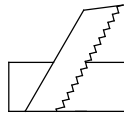

- 3LEDS: 40x88mm
- 6LEDS: 40x168mm
- 12LEDS: 40x328mm
- 18LEDS: 40x486mm
- 3X3LEDS: 95x95mm

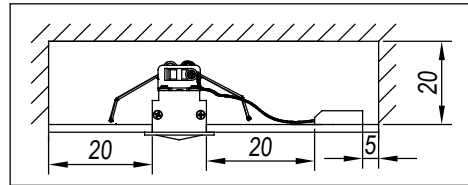
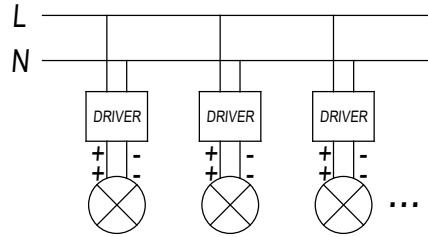

1

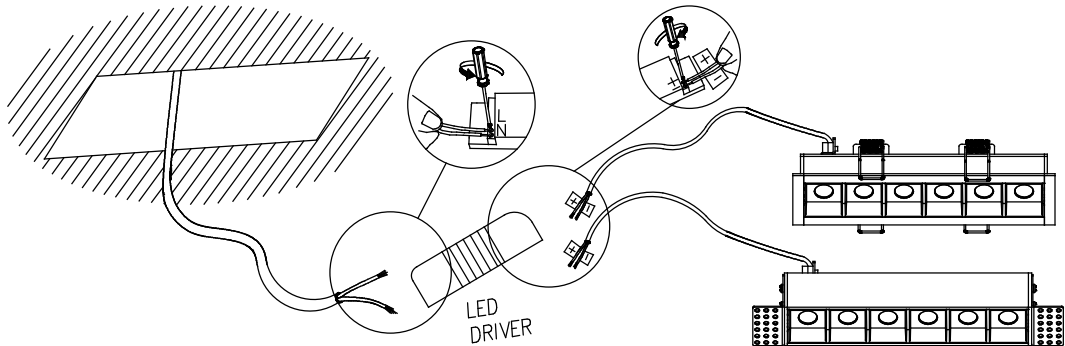
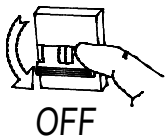

TRIM/CON MARCO

2

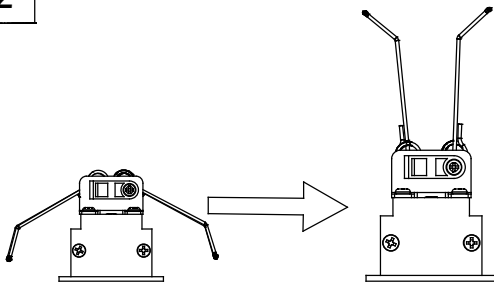

3

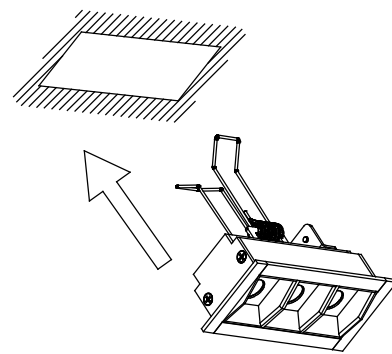

4

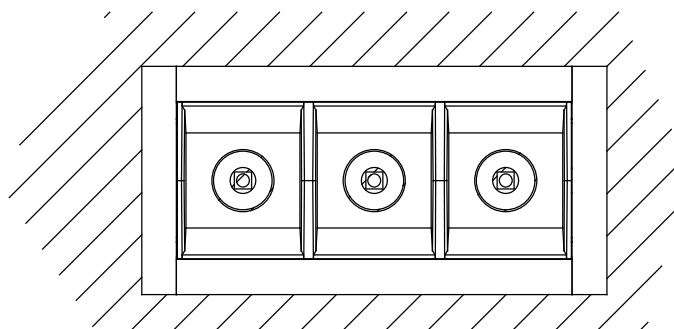
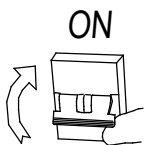

TRIMLESS/SIN MARCO

